



H-184, H-185, H-186
H-196, H-201

PEANUT DISPENSER

1-800-295-5510
uline.com

TOOLS NEEDED

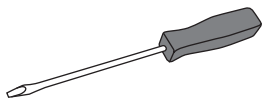

Standard screwdriver

HARDWARE NEEDED

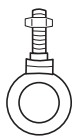

Eye Bolt x 2



Hook x 2



Cleat x 1

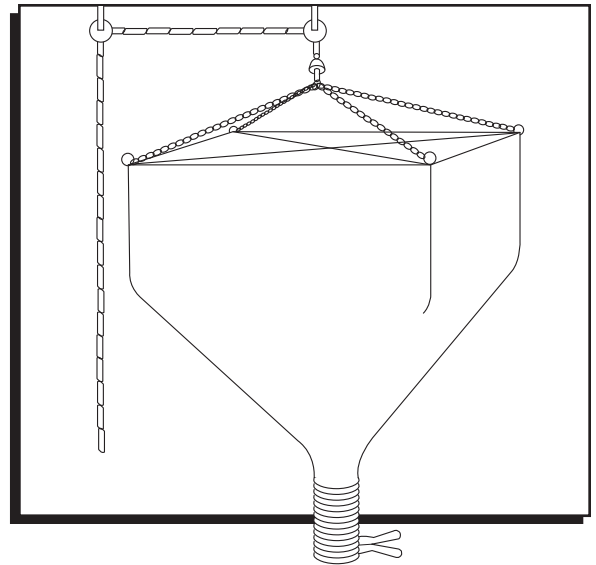

INSTRUCTIONS

PARTS INCLUDED

1. Canvas bag with 1 ft. flex tubing, attached with steel ring and stainless steel clamp, 2 black steel rods (H-184 has 2 additional steel rods with orange tips) and valve assembly with clamp.
2. Packed inside bag: chain assembly and rope assembly with 2 pulleys and 1 U-bolt attached.
3. Models H-196 & H-201 come with 4 pieces of 1/2" PVC pipe with plastic eye-ends attached. (H-184 includes 2 U-bolts)

INSTALLATION INSTRUCTIONS



Note: Read instructions thoroughly. Remove all components from box and locate all parts. Remove pulley and U-bolt from rope.

1. Attach pulley to ceiling using hook and eye bolt. Make sure one is positioned directly above center of dispenser and other clears the side of bag so rope will not interfere with raising and lowering of bag. Ensure method of tie-off for rope is in place (cleat, anchor, post, etc.).
2. Remove clamp from inside of valve, then slide it over flex tubing. Insert the valve flange into bottom of flex tubing (be sure tubing covers entire flange). Turn yellow handles to correct position for operator, slide clamp down around tubing covering flange and tighten with screwdriver. (See Figure 1)

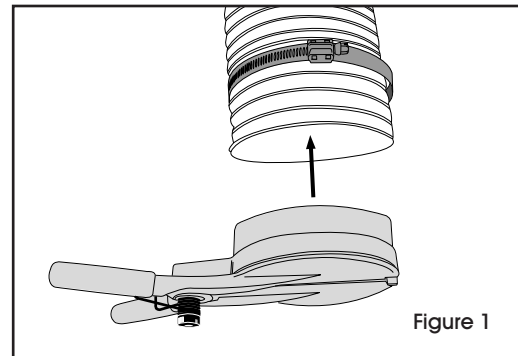

Figure 1

3. **This step is for H-184 only.** Locate two black rods with orange tips. Insert the tail of each rod into the bottom set of grommets on the bag in a X formation, tip pointed up. (See Figure 2) Place U-bolt in center of "X", re-attach plate, thread nuts and tighten.

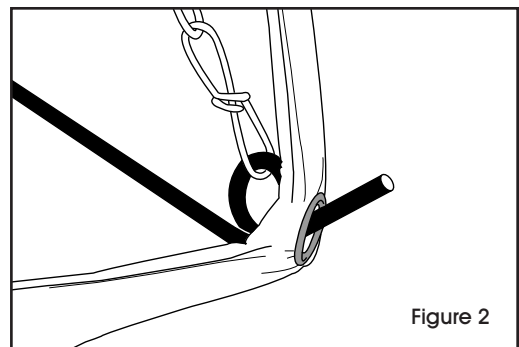
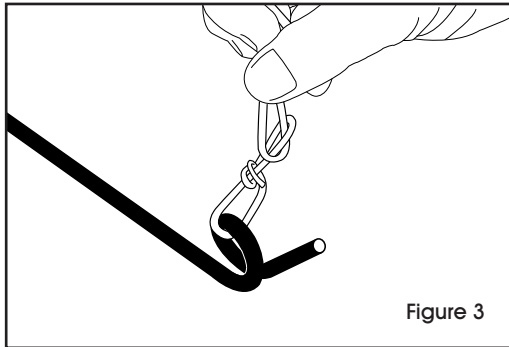

Figure 2

INSTRUCTIONS CONTINUED

4. Locate the 2 black rods and slide the chains back to the loop on each of the four ends. (See Figure 3)



5. Insert steel rod "tails" through grommets at corners of bag. (See Figure 3.) Position rods to form an "X" across the top of the bag with tail and loop pointing up. (Do not try to fit grommet into loop.)
6. Place U-bolt in center of "X", re-attach plate, thread nuts and tighten. (See Figure 4) For H-184, H-185 & H-186 skip to step 8.

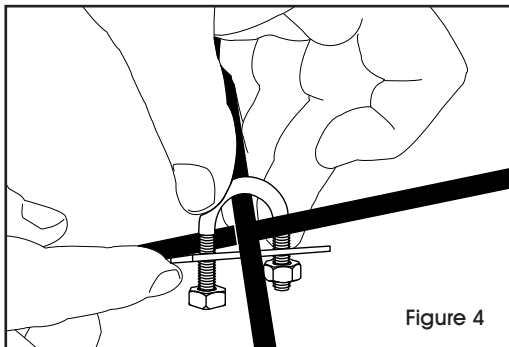

7. This step is for H-196 and H-201 only. Slide four PVC pipes into hems at top of bag to form square. Make sure holes of eye-ends are facing up.

8. This step is for H-196 and H-201 only. Remove nut from eye-bolt at end of chain. Position two corner eye ends on top of each other, put end of bolt through holes and tighten with nut. Repeat at each corner to form square.
9. Thread rope through both pulleys. Attach pulleys to ceiling fixtures, raise bag to desired height and tie off rope.

